

---

## Contents

1	General information.....	3
1.1	Dear Customer,.....	3
1.2	Contact information.....	3
1.3	Notes on Operation Instructions.....	3
1.3.1	General information on Operation Instructions.....	3
1.3.2	Scope of these Operating Instructions.....	3
1.4	Other valid documents.....	4
1.5	Warranty and liability.....	4
1.6	Intended use.....	4
2	Safety information.....	5
2.1	Identification of danger levels.....	5
2.2	Information on the unit.....	5
2.3	On-site installation.....	5
2.4	Media quality.....	5
2.5	Maintenance and repairment.....	6
2.6	Trouble-free operation.....	6
2.7	Patient chair.....	6
2.8	Ventilation slots.....	6
2.9	Intermittent operation.....	6
2.10	Care and cleaning agents.....	7
2.11	Modifications and extensions of the unit.....	7
2.12	Electromagnetic compatibility.....	7
2.13	Dismantling/Installation.....	7
3	Unit description.....	8
3.1	Standards/approvals.....	8
3.2	Technical data.....	8
3.3	Dental unit overview.....	10
3.4	Installation and setting.....	11
3.5	Steps of installation.....	11
3.6	Modulation.....	13
4	Operation.....	14
4.1	Starting up the dental unit.....	14
4.1.1	Initial startup.....	14
4.1.2	Switching the dental unit on/off.....	14
4.2	Foot control.....	15
4.3	Patient chair.....	16
4.3.1	Safety instructions.....	16

---

4.3.2	Armrest .....	17
4.3.3	Adjusting the headrest.....	17
4.3.4	Moving the patient chair .....	18
4.3.5	Moving the patient chair to the entry/exit position .....	18
4.3.6	Moving the patient chair to the emergency position.....	19
4.3.7	Moving the patient chair to the clean-up position.....	19
4.3.8	Music panel.....	19
4.4	Dentist element.....	20
4.4.1	Maximum load capacity.....	21
4.4.2	Height adjustment.....	21
4.4.3	The control panel on the dentist element.....	21
4.4.4	Placing the instruments in their holders .....	23
4.4.5	Operating the handpieces .....	23
4.4.6	Adjusting the handpiece's working air pressure and water flow.....	23
4.4.7	3-way syringe .....	24
4.5	Assistant element.....	25
4.5.1	Moving the assistant element.....	25
4.5.2	The control panel on the assistant element .....	25
4.5.3	3-way syringe .....	26
4.5.4	Saliva ejector .....	26
4.5.5	Spray aspirator .....	26
4.6	Water unit.....	26
4.6.1	Tumbler filler .....	27
4.6.2	Flushing the swiveling cuspidor bowl .....	27
4.6.3	Swiveling cuspidor bowl .....	27
4.6.4	Air switch .....	27
4.6.5	Water alternative switch .....	27
4.6.6	Pure water bottle .....	27
4.7	Operating light.....	27
5	Cleaning and maintenance by the practice team.....	28
6	Maintenance by the service engineer .....	31
6.1	Inspection and maintenance.....	31
6.2	Safety checks.....	31
7	Malfunctions .....	32
8	Disposal.....	33
9	Overview of graphic symbols used .....	34
10	Electrical schematic diagram .....	35
11	Water-air layout diagram .....	36

---

# 1 General information

## 1.1 Dear Customer,

We are pleased of your purchase on the New series of S1 top-mounted dental unit. New series S1 top-mounted that chosen as your dental unit stands for the features of easy operation, innovative comfort and high quality design.

These Operating Instructions are designed to assist you prior to initial use and whenever you require information later on.

We wish you a great deal of success and pleasure with S1 Top-mounted dental unit.

## 1.2 Contact information

## 1.3 Notes on these Operating Instructions

### 1.3.1 General information on the Operating Instructions

#### **Observe the Operating Instructions**

Please familiarize yourself with the unit by reading through these operating instructions before putting it into operation. It is essential that you comply with the specified warning and safety information.

#### **Keep documents safe**

Always keep the Operating Instructions handy in case you or another user require information at a later point in time.

#### **Help**

If you reach an impasse despite having thoroughly studied the Operating Instructions, please contact your dental suppliers.

### 1.3.2 Scope of these Operating Instructions

This document describes the full version of your unit. It may therefore cover components that are not included in the unit you purchased.

---

## 1.4 Other valid documents

You dental unit can be equipped with additional components that are described in separate sets of operating instructions. The instructions as well as any warning and safety information contained therein also must be observed.

## 1.5 Warranty and liability

### Warranty Passport

To safeguard your warranty claims, please complete the attached “Warranty Passport” together with the service engineer immediately after the installation of your unit.

### Maintenance

Maintenance must be performed at scheduled intervals to ensure the operational and functional reliability of your product and to protect the safety and health of patients, users and other persons. For more information, please refer to “Maintenance by the service engineer”. The owner is responsible for making sure that all maintenance activities are performed.

As manufacturers of medical electrical equipment, we can assume responsibility for the safety properties of the unit only if maintenance and repairs on the unit are performed either by us or by agencies which we have expressly authorized and if components of the unit are replaced by original spare in case of failure.

### Exclusion of liability

In the event that the unit owner fails to fulfill its obligation to perform maintenance activities or ignores error message, we cannot assume any liability for any damage thus incurred.

## 1.6 Intended use

This dental unit is intended for the diagnosis, therapy and dental treatment of humans by properly trained and qualified personnel. This device is not intended for operation in areas subject to explosion hazards.

Intended use also includes compliance with these Operating Instructions and the relevant maintenance instructions.

---

## 2 Safety information

### 2.1 Identification of danger levels

To prevent personal injury and material damage, please observe the warning and safety information provided in this document. Such information is highlighted as follows:

#### WARNING

A possibly dangerous situation that could result in serious bodily injury or death.

#### NOTICE

A possibly harmful situation which could lead to damage of the product or an object in its environment.

#### IMPORTANT

Application instructions and other important information.



### 2.2 Information on the unit

Two symbols can be found on the unit rating plate.

### 2.3 On-site installation

The on-site installation must have been performed according to our requirements. The details are described in the document “Steps of installation” in Paragraph 3.5.

### 2.4 Media quality

The air and water supplies must meet the requirements specified in the installation instructions. Use only drinking water and dry, oil-free and hygienically clean air for the water and air supplies of the unit.

**As the owner of the unit, you are generally responsible for the water quality.** For this reason, you should check the water quality at regular intervals. Please contact your specialized dealer or your relevant dental association for the respective national requirements and measures.

Highly immunosuppressed patients should not come in contact with water from the unit. The use of sterile solution is recommended.

---

## 2.5 Maintenance a repair

### Authorized technical personnel and spare parts

As manufacturers of dental units and in the interest of the operational safety of your unit, we stress the importance of having maintenance and repair of this unit performed only by ourselves or by agencies expressly authorized by us. Furthermore, failed components must always be replaced with original spare parts.

### Maintenance intervals

In order to ensure the operational safety and reliability of your unit and to avoid damage due to natural wear, you as the unit owner must have your unit checked regularly by an authorized service engineer. Furthermore, safety checks must be performed. Please contact your dental depot to obtain a maintenance offer. For more information, please refer to "Maintenance by the service engineer".

## 2.6 Trouble-free operation

Use of this unit is permissible only if it works properly without malfunctions. If trouble-free operation cannot be ensured, the unit must be taken out of service, checked by authorized technicians for malfunctions and, if necessary, repaired.

## 2.7 Patient chair

Please observe the maximum load capacity of 135 kg for the patient chair.

The weight distribution complies with the ISO 7494-1:2018 standard. The safety test is according to IEC60601-1:2007.

**The patient's arms and legs must be testing on the upholstery of the chair.**

## 2.8 Ventilation slots

Under no circumstances may the ventilation slots on the unit be covered, since otherwise the air circulation will be obstructed. This can cause the unit to overheat.

Do not spray liquids such as disinfectants into the ventilation slots. This may lead to malfunctions. Use wipe disinfection only in the vicinity of the ventilation slots.

## 2.9 Intermittent operation

The motors of the unit are designed for intermittent operation corresponding to the dental mode of treatment.

Drive motors for patient chair and backrest: max. 10% duty cycle, cycle duration 300s

---

### **2.10 Care and cleaning agents**

Unsuitable may corrode the surface of the unit. Therefore, use only care and cleaning agents which have been approved by MAGNUS. For more information.

### **2.11 Modifications and extensions of the unit**

Modifications to this unit which might affect the safety to the unit owner, patients or other persons are prohibited by law.

For reasons of product safety, this product may be operated only with original MAGNUS accessories or third-party accessories expressly approved by MAGNUS. The user assumes the risk of using non-approved accessories.

### **2.12 Electromagnetic compatibility**

Medical electrical devices are subject to special precautionary measures with regard to electromagnetic compatibility (EMC).

Portable and mobile RF communications equipment may interfere with medical electrical equipment. Therefore, the use of such devices (e.g. cellular phones) in practice of hospital environments must be prohibited.

### **2.13 Dismantling/Installation**

When dismantling and re-installing the unit, proceed by ourselves or by agencies expressly authorized by us in order to guarantee its proper functioning and stability.

---

### 3 Unit description

#### 3.1 Standards/approvals

The S1 dental unit complies with the following standards, among others:

- IEC 60364-7-710
- IEC 60601-1:2005+A1:2012
- IEC 60601-1:2006+A1:2013
- IEC80601-2-60
- ISO 7494-1:2018
- ISO 7494-2:2003
- ISO 9680:2007
- ISO 13485:2016

This product bears the CE mark in accordance with the provisions of Council Directive 93/42/EEC of 14 June 1993 concerning medical devices.

#### 3.2 Technical data

Model designation:	S1
Input max power:	600VA
Power connection:	230 V AC $\pm$ 10% 50/60 Hz
Rated current:	3A at 230 V
Fuse for the unit:	$\varnothing$ 5 250V AC 6A slowblow
Protection class:	Class I equipment
Degree of protection against electrical shock:	 Type A applied parts
Degree of protection against ingress of water:	Ordinary equipment (without protection against ingress of water) The foot control has an IP S1 degree of protection against liquids (drip-proof).
Mode of operation:	Continuous operation with intermittent loading corresponding to the dental mode of working. Permanently connected unit.



---

Transport and storage conditions:	Temperature: -40 °C – +70 °C Relative humidity: 10% – 95% Barometric pressure: 50kPa – 106kPa
Operating conditions:	Ambient temperature: 5 °C – 40 °C Relative humidity: 30% – 85% Barometric pressure: 860 hPa – 1060 hPa
Input water pressure:	0.2-0.4MPa
Input air pressure:	0.55-0.8Mpa
Displacement of air compressor:	≥ 55L / min
Installation site:	≤ 3000m above sea level
Tests/Approvals:	See “Standards/Approvals”
Year of manufacture:	 20XX (on the rating plate)

### 3.3 Dental unit overview

The dental unit comprises the following main components:

#### S1 Dental Unit (Top-Mounted)

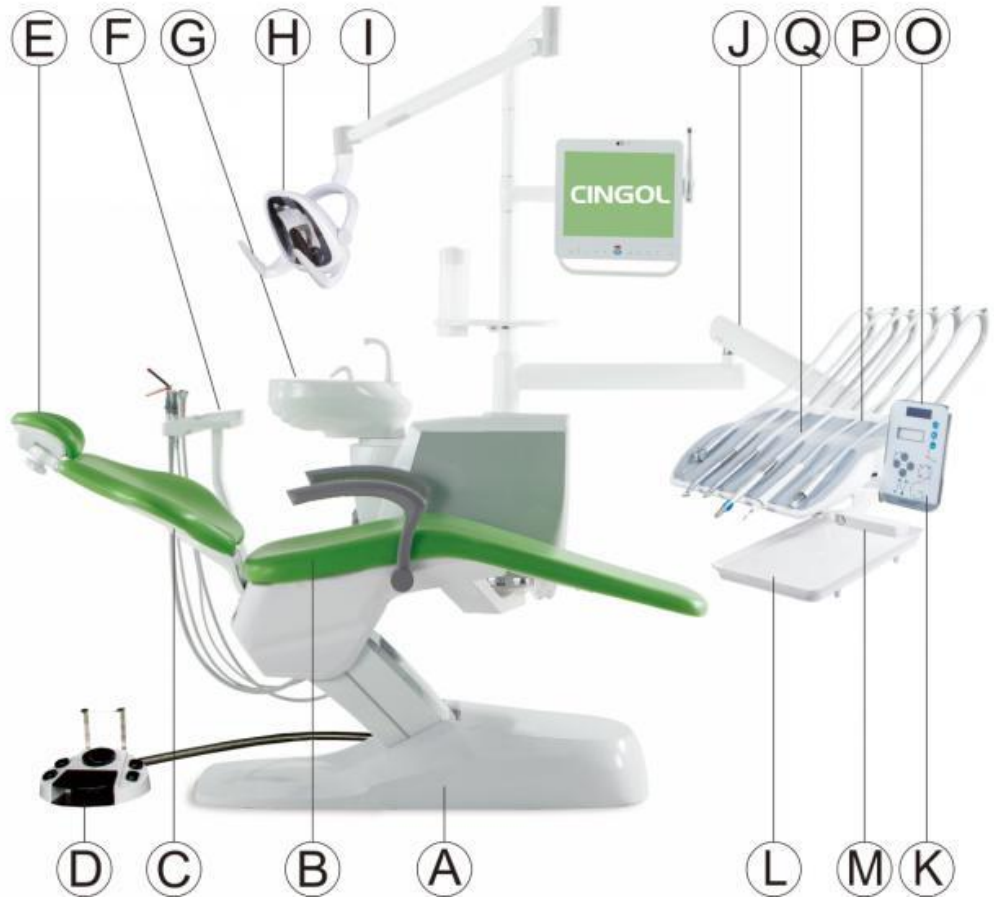

A	Chair Base	E	Headrest	I	Lamp arm	M	Air Lock	Q	Hang hose
B	Cushion	F	Assistant control tray	J	Balance arm	N	Instrument rack	R	Music Panel
C	Backrest	G	Spittoon	K	Main control Panel	O	Air pressure meter		
D	Foot pedal	H	Operating light	L	Instrument tray	P	Silicon pad		

## S1 Dental Unit (Hanging Type)

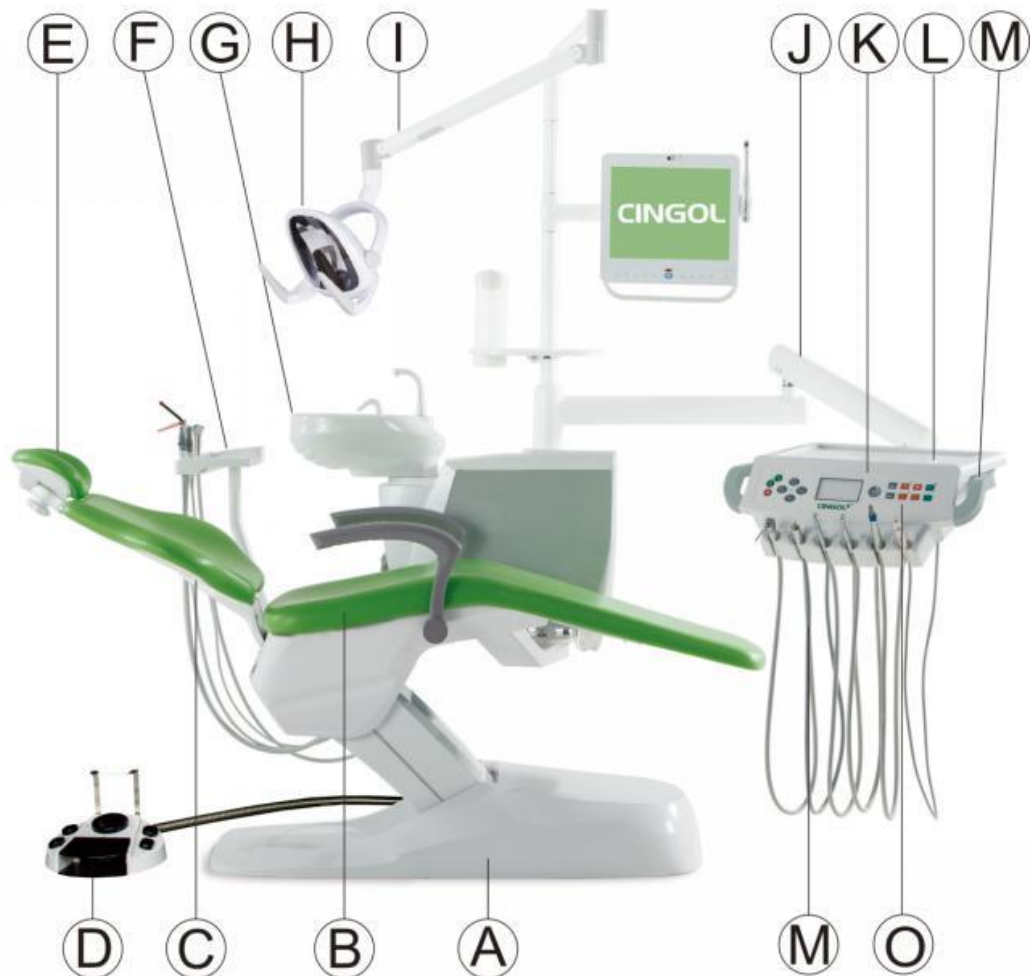

A	Chair Base	E	Headrest	I	Lamp arm	M	Air Lock
B	Cushion	F	Assistant controller	J	Balance arm	N	Instrument rack
C	Backrest	G	Spittoon	K	Air pressure meter	O	Main Control Panel
D	Foot pedal	H	Operating light	L	Instrument tray	P	Music Panel

---

## 3.4. Installation and setting

### 3.4.1 Installation conditions

To make sure dental unit work well the conditions of air, water, electricity for the device should be :

Air supply&air pressure: 0.5 MPa--0.8MPa

Water supply&Water pressure: 0.2MPa--0.4MPa

Power supply: AC 230 $\pm$ 10% /AC 110 $\pm$ 10% 50Hz/60Hz

( the rated voltage according to different country refers to the order)

### 3.4.2 Preparation for installation

Decide the suitable location of installation place according to the elements like general situation, day lighting,convenience for use. Where should be clean, dry, well ventilated,cool,and the floor must be solid,firm and flat.what' s more,the installation room should be wide enough for the arm stretch. After decide the location, you can connect the wires and tubes from outside ends as below:

### 3.4.3 Arrangement of connecting water in/out, electricity, compressor air supply

Get the things below ready before installation

A) End of power wire should stretch over 80mm from ground.

B) Adopt the pipe of water or air with width 22 mm

C) Outlet pipe of water should have internal diameter 40mm, stretch over 50mm from ground

## 3.5 Steps of installation

### A)Patient chair installation

Fit the chair base at the planned place. If the installation floor is not flat enough,user can fix the five pieces of enclosed leveling screws(M12\*15) into the five screw holes (M12),adjust the height of five screws to make sure the dental unit stand firmly onto the ground.and then fix four pieces of expansive screws into the ground, to make sure the device works stably and quietly.

### B)Mount the patient chair cushion

Stretch the backrest to the end first,fix two flat head screws into screw holes of the seat through the screw slots of the base frame,adjust the seat board to best location to make sure the bottom surface touch firmly with the metal frame. Finally fix the rest two screw firmly.

### C)Outlet unit installation

Seal this device' s outlet tubes with the inlet tubes from outside tightly, thus to avoid the water and air input or output leak outside. The outlet unit may set in the frame base or out side of the base, it depends on your choice. Open the cover you can find fix the outlet tubes.

### D)Tubes connection

You must get rid of the water and air inside this dental unit,as well as the waste, note to get the tubes connected tightly with outside tubes.

### E)Dental lamp installation

Pass the power wire through the supporting arm inside,and connect it with the wire from pillar bases of the dental unit,put the clasp end into the pillar and then fix the supporting pillar onto the dental unit,(mind not to damage the power wire when connecting wire) Pass the power wire from the pillar into the cover ring of dental to fit together with the wire of dental lamp.insert the connective pivot into the balance arm,and fix with screw.

F) Connect power supply

Put the plug into the power socket, which must have the wire connected to ground. The wire should have the copper wire inside less than 1mm. Make sure this wire is connected well with ground.

**3.6 Modulation**

Now the device is at state of modulation after different parts are fitted well. Open the base box, check the air pressure meter of air filtering adjusting valve whether it reads 0.6mpa, if not, adjust the valve to keep the air pressure reading 0.6mpa. (Method: pull up the rotary knob at the top air pressure valve, turn clockwise for increasing pressure, turn anticlockwise for reducing pressure.)

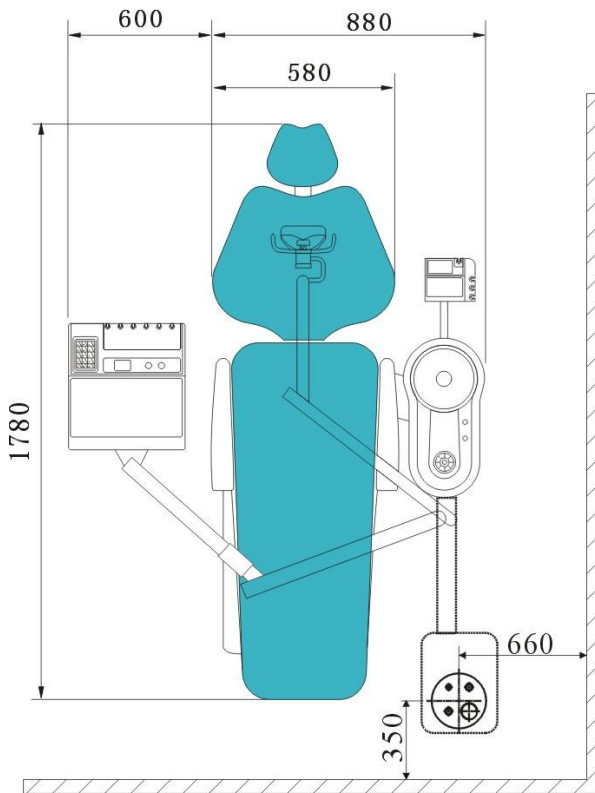

Installation diagram of external floor box

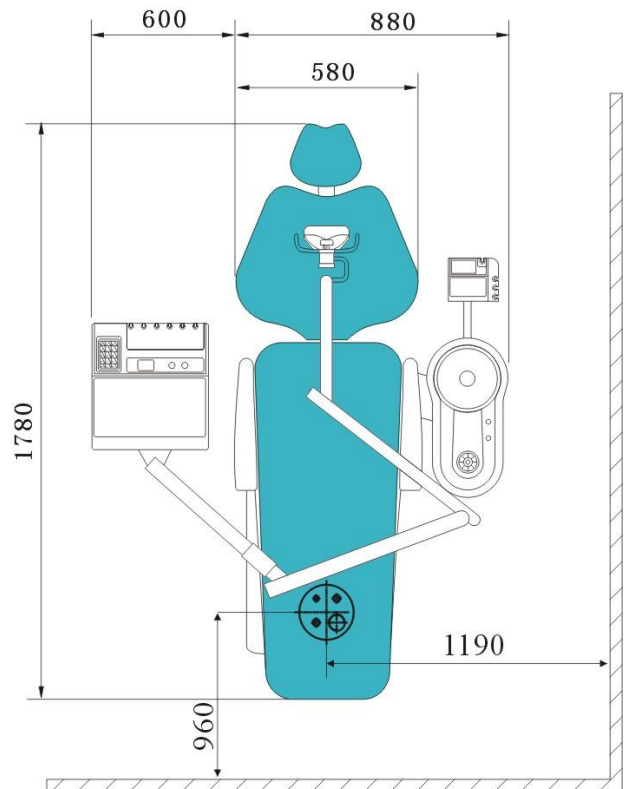

Installation diagram of built-in floor box

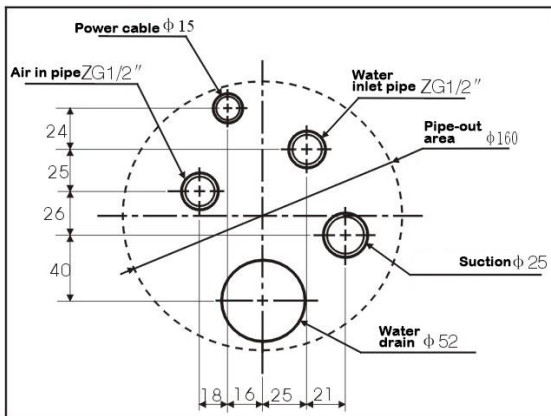

Outlet Planar Graph

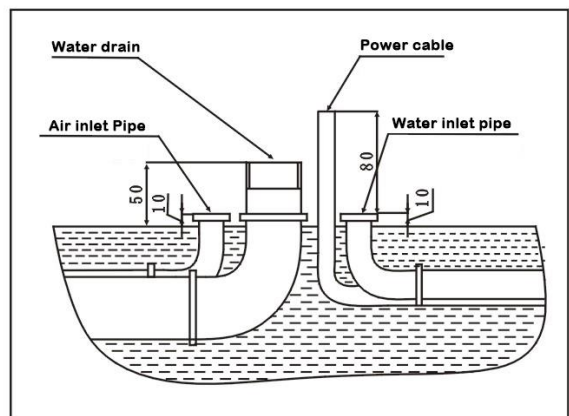

Pipe Outlet Graph

## 4 Operation

### 4.1 Starting up the dental unit

#### 4.1.1 Initial start-up

Sanitation must be performed prior to initial start-up of your dental unit. Sanitation takes approx. 24 hours.

#### 4.1.2 Switching the dental unit on/off

The dental unit thus features a main switch at the patient chair and an emergency switch at back of the patient chair.

##### 4.1.2.1 Main switch

Following switch-on, the dental unit is connected to the power, water and air supply.



### ! NOTICE

On completing your work, you should switch the dental unit off with the main switch both for safety reasons and to reduce its power consumption.

##### 4.1.2.2 Emergency switch

Press the emergency switch, only cut off the power supply of dental unit.

### 4.2 Foot control

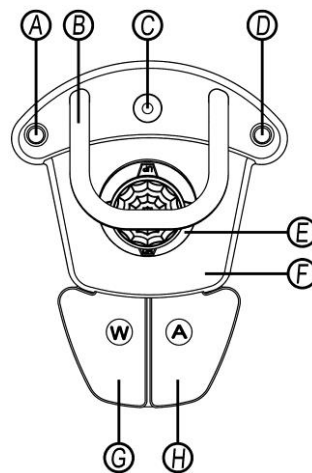

A	Cuspidor Flush Function
B	Foot Switch Handle
C	Chip blower switch
D	Operating light switch
E	Foot switch. (Control the patient chair movement.)
F	Shell
G	Water Pedal
H	Air Pedal

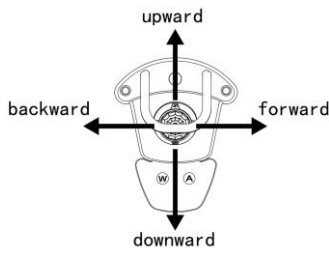

### Operating foot switch

The foot switch use to control movement of the patient chair. Uplifted or descending the chair couch movement can be controlled by sliding the foot switch to the up or down. Similarly, backward or forward backrest movement can be controlled by sliding the foot switch to the left or right.

### Air pedal and Water pedal

The handpiece is removed from its holder on the dentist element.

- Step on the air pedal. The handpiece motor rotates, and blowing chip air flows out the cooling holes on the handpiece.
- Step on the water pedal. Cooling water flows out from the cooling holes on the handpiece.
- Step on the air and water pedals simultaneously. The handpiece motor rotates and spraying the cooling spray.



### Chip blower switch

The handpiece is removed from its holder on the dentist element.

- Step on the button of the chip blower switch. Air flows out the cooling holes on the handpiece.



### Cuspidor Flush switch

Place the tumbler under the tumbler filler.

- Press the switch (Cuspidor Flush). The Cuspidor is flushing with water for the preset time.
- Pressing the switch (Cuspidor Flush) again stops the filling function immediately.



### Operating light switch

- Press the switch (Operating light) on the foot control. The operating light is opened to the weak light.
- Press the switch (Operating light) again. The operating light is shut off.



## ! IMPORTANT

### Operating light switch

Please open the switch on the operating light before use the button on the foot control or the key on the control panel.

### 4.3 Patient chair

The patient chair comprises the following main components:

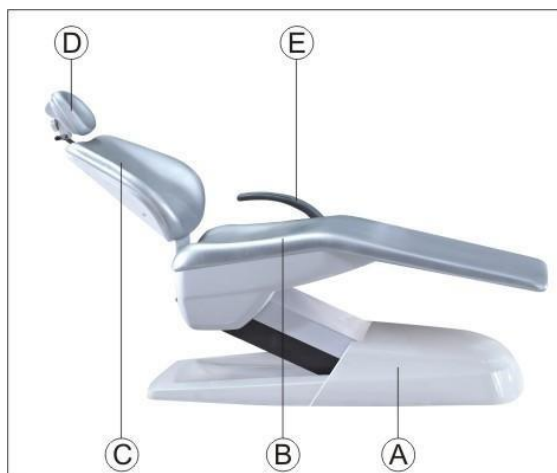

A	Chair base and cover
B	Seat
C	Backrest
D	Headrest
E	Left armrest

#### 4.3.1 Safety instructions



#### WARNING

**The free space under the patient couch and up to the water unit can be decreased due to chair movements.**

Parts of the patient's or user's body may be pinched or crushed.

- Do not allow any limbs to be caught between the chair upholstery and the chair base. Please make sure that the patient's arms and legs rest on the upholstery of the chair.
- Do not place any objects on the base of the chair.



#### WARNING

**The maximum load capacity of the patient chair is 135 kg acc. to ISO 6875.**

If the maximum load capacity is exceeded, a risk of damage to the patient chair and injury of the patient exists.

- Never allow any persons who weigh more than 135 kg to sit on the patient chair.



## WARNING

### **Objects protrude into the movement range of the chair.**

There is a risk of crushing the patient and damaging the objects.

- Make sure that no objects such as e.g. windows, drawers or other devices protrude into the movement range of the dental unit.

## IMPORTANT

### **Chair interlock**

As long as a treatment instrument is activated, all functions for moving the patient chair disabled for safety reasons.

If chair movement is permanently blocked, please contact your service engineer.

#### **4.3.2 Armrest**

The patient chair can be equipped with armrests on the left. The armrest is stationary.

#### **4.3.3 Adjusting the headrest**

The headrest enables you to adjust the patient's head in a way that optimally supports viewing of hard-to-access areas of the patient's mouth.

##### **Patient height adjustment**

The headrest can be adjusted to the patient's height by pulling out or pushing in the headrest extension.

##### **Setting the jaw position**

The headrest enables you to change between the maxillary and mandibular positions without adjusting the headrest extension.

1. Loosen the wrench (A) counterclockwise, the headrest is unloaded.
2. Holding the headrest by hand, raise or lower it to the required position.
3. Tighten the wrench (A) clockwise, the headrest is locked again.

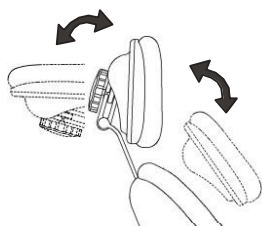
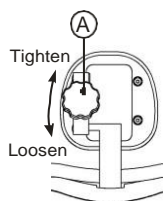
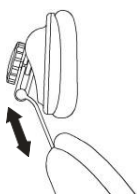

---

#### 4.3.4 Moving the patient chair

The chair movement can be controlled via the fixed keys on the dentist element and the assistant element, or via the foot switch.

##### Via the dentist element

Picture of the control panel on the dentist element, see “*The control panel on the dentist element*”.



The chair couch moves up as long as the key (*Chair UP*) is pressed.



The chair couch moves down as long as the key (*Chair Down*) is pressed.



The backrest tilts up as long as the key (*Backrest UP*) is pressed.



The backrest tilts down as long as the key (*Backrest Down*) is pressed.

##### Via the assistant element

See “4.3.2 *Via the dentist element*”.

##### Via the foot switch on the foot control

See “4.2 *Foot control/Operation foot switch*”.

#### 4.3.5 Moving the patient chair to the entry/exit position



The following functions are triggered for simple patient entry and exit in the entry/exit position:

- The patient chair moves to the lowest position
- The backrest moves to an upright position

Moving the patient chair to the entry/exit position can be implemented by pressed the key on the dentist element.



#### WARNING

**The patient’s feet may get caught in the instrument hoses of the dentist element when he enters of leaves the patient chair.**

The patient may trip or fall.

- Turn the dentist element outward before the patient enters of leaves it.

---

#### 4.3.6 Moving the patient chair to the emergency position



When the emergency position key is pressed, the patient chair immediately moves to a position suitable for emergency position of the patient.

- The patient chair moves up to highest position.
- The backrest rotates backward to  $-5^{\circ}$ .

Moving the patient chair to the emergency position can be implemented by pressed the key on the dentist element.

#### 4.3.7 Moving the patient chair to the clean-up position



When the clean-up positioning key is pressed, the patient chair immediately moves to a position suitable for cleaning.

- The patient chair moves up to highest position.
- The backrest moves to an upright position.
- The operating light is shut down.
- The flushing function is opened.

#### 4.3.8 Music Panel

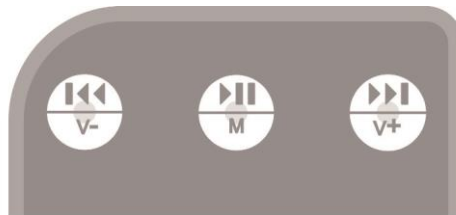

##### Touch-sense Bluetooth Music Panel

Features: High-sensitive support 3 buttons conduction, and support blue LED background as well(when power on or pushing buttons, LED light on, and automatically off around 5 seconds).

Touch Panel:



Short press this button for former song, and long press for reducing voice.



Short press this button for next song, and long press for increasing voice.



Short press this button for Play/Stop, and long press for MODE changing.

Bluetooth connection: It will enter blue-tooth mode when power-on with the “hello MAGNUS” voice. Or when play the music list from flash drive, long press MODE changing button to switch to blue-tooth mode, a “ding” sound will be heard at the same time. Cell phone must allow applications to discover and pair blue-tooth devices. When discovering “MAGNUS” , enter password “6666” for pair, so can play music with a blue-tooth player.

#### 4.4 Dentist element

The dentist element comprises the following main components:

S1-Top-mounted

S1-Hanging Type



#### S1-Top-mounted

J	Balance arm	L	Instrument tray
M	Air-lock	O	Main control panel
P	Silicon pad	Q	Handpiece hose

#### S1-Hanging Type/Cart Type

J	Balance arm	M	Air-lock
K	Instrument tray plastic cover	N	Handpiece hose
L	Instrument tray	O	Main control panel



#### 4.4.1 Maximum load capacity

The maximum load of the dentist element is 1.5 kg(same for hanging type and top-mounted ).

#### 4.4.2 Height adjustment (Apply to S1)

1. Hold the handle and press the locking button by the thumb.
2. Adjust the dentist element to achieve an ergonomic instrument height.
3. Loosen the thumb; the button automatically resets. The dentist element is locked on the height adjustment.



#### 4.4.3 The control panel on the dentist element

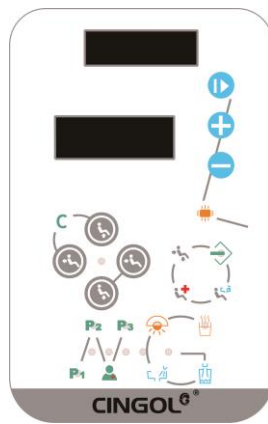

(Top-Mounted)

(Hanging Type/Cart Type)

#### 4.4.3.1 Chair movement

The keys in chair movement area control the patient chair movement. See “4.3.2 Moving the patient chair”.

#### 4.4.3.2 Tumbler filling

1. Place the tumbler under the tumbler filler.
2. Press the key (*Tumbler Filling*). The tumbler is filled with water for the preset time.

Pressing the key (*Tumbler Filling*) again stops the filling function immediately.



#### Setting the filling time

1. Pressing the key (*Set*) (about 2second) until the buzzer in the water unit call. The LED above the key lights up.
2. Pressing the key (*Tumbler Filling*) until the filling water rise to the desired position.
3. Press the key (*Set*) again finishes the setting the filling time. The LED above the key lights out

**Flushing** 

**Flushing of the cuspidor bowl**

Press the key (*Flushing*). The flushing function is activated for the preset flushing time.

Pressing the key (*Flushing*) again stops the flushing function immediately.

**Setting** 

**Setting the flushing time**

1. Pressing the key (Set) (about 2second) until the buzzer in the water unit call. The LED above the key lights up.
2. Press the key (Flushing) to set the flushing time. According to the following table:

Press Times	Buzzer Call	LED Flicker	Flushing time
One time	One time	One time	30 seconds
Twice	Twice	Twice	3 minutes
Three times	Three times	Three times	15 minutes
Four times	Four times	Four times	Always flushing

3. Press the key (Set) again finishes setting the flushing time. The LED above the key lights out.

**4.4.3.4 Heating of the tumbler water**

**Heating** 

4.4.3.3

Press the key (*Heating*). The heating function is activated. The tumbler water temperature can be kept at 40°C ± 5°C.

If the LED in the key is lighting, the heater in the water unit is working. Pressing the key (*Heating*) again stops the heating function immediately.

**4.4.3.5 X-ray viewer**



- Press the key. The x-ray viewer lights up.
- Press the key again. The x-ray viewer lights out.

**4.4.3.6 Operating light**



The key is equivalent to the button on the foot control. See “4..2 Foot control/Operating light switch. ”.

**4.4.3.7 Memory position**

Dentist able to choose the regular use patient position for efficient work, there are “P1”, “P2”, “P3” 3 memory positions for daily use (Top mounted use only)



#### 4.4.4 Placing the instruments in their holders

Every handpiece has a corresponding switch on the holder. When the handpiece is removed from their holder, the switch will open the pile-up valve and the removed handpiece is unlocked.

Therefore, always make sure that all handpieces are placed in the correct instrument holders. If any handpieces are placed in the wrong holders, the removed handpieces will not be activated.



#### NOTICE

Over-tensioning or pinching the hoses may cause the media pipes to leak. Ensure that you do not pull or bend the instrument hoses too much.

#### 4.4.5 Operating the handpieces

See "4.2 Foot Control".



#### IMPORTANT

Also observe the operating instructions of the handpiece.

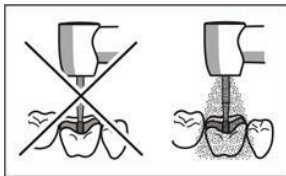

#### WARNING

**Handpieces can be operated without coolant.**

Tooth substance can be damaged by frictional heat.

- Always make sure that the treatment area does not overheat whenever you switch the coolant off.

#### 4.4.6 Adjusting the handpieces' working air pressure and water flow

The handpieces' working air pressure and cooling water flow can be adjusted by their adjust valves. The control valves are shown in the following illustration.



Top mounted

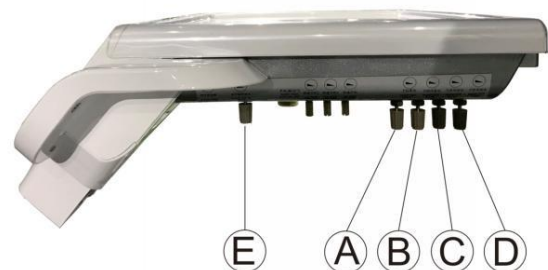

Hanging Type /Cart Type

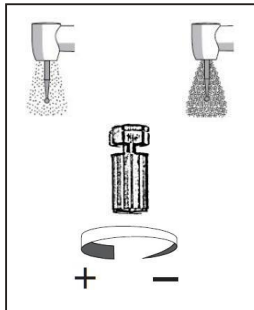

A	Water regulating valve for the syringe in the first holder
B	Water regulating valve for the handpiece in the second holder
C	Water regulating valve for the handpiece in the third holder
D	Water regulating valve for the handpiece in the fourth holder
E	Water regulating valve for the scaler in the fourth holder

### Setting the spray amount

The spray amount can be set by adjusting the water regulating valve and the blowing air regulating valve.

1. Remove the handpiece from its holder.
2. Step on the air pedal and the water pedal at the same time.
3. Set spray amount by turning the knob of the water regulating valve and the blowing air regulating valve.

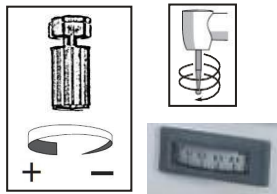

### Setting the handpiece's working air pressure

1. Remove the handpiece from its holder.
2. Step on the air pedal.
3. Set the working air pressure displayed on the Gas-pressure meter by turning the knob of the corresponding regulating valve.

#### 4.4.7 3-way syringe

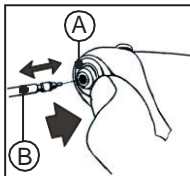

### Removing/attaching the tip

4. Press the ring (A).
5. Removing/attaching the tip (B).
6. Loosen the thumb; the ring automatically resets. The tip will be locked if it is attaching on the 3-way syringe.

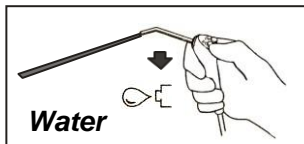

### Operating the 3-way syringe

- Press the water button. Water flows out the tip.

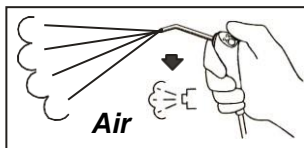

- Press the air button, Air flows out the tip. The 3-way syringe is used as a chip blower.

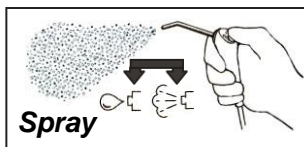

- Press the water and air buttons simultaneously. Spray flows out the tip.



## 4.5 Assistant element

The dentist element comprises the following main components:

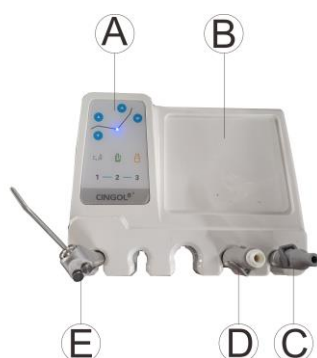

A	Control panel
B	Instruction holder
C	Spray aspirator
D	Saliva ejector
E	3-way syringe

### 4.5.1 Moving the assistant element

The assistant element can be moved in the dental assistant's field of activity, but can't be adjusted in height. Don't place anything on the assistant element.



#### NOTICE

**The assistant element can be positioned above or below the backrest.**

The patient could be pinched during chair movements or the chair could be damaged.

- Move the assistant element out of the collision zone before moving the patient chair.

### 4.5.2 The control panel on the assistant element

The key functions are the same as the key functions on the dentist element. See "4.4.3 The control panel on the dentist element".



### 4.5.3 3-way syringe

See “4.4.8 3-way syringe”.

### 4.5.4 Saliva ejector

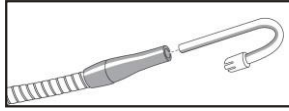

A curved cannula that can be lodged in the corners of the mouth is provided for saliva ejection.

Saliva ejection can be used when it is removed from the holder.

### 4.5.5 Spray aspirator

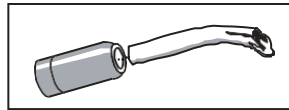

Spray aspirator can be used with its cannula when it is removed.

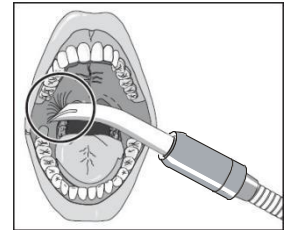

## ⚠ NOTICE

**The cannula attaches itself to the oral mucosa.**

The patient's oral mucosa is irritated by the vacuum.

- Make sure to hold the spray aspirator cannula in such a way that the cannula opening cannot attach itself to the oral mucous membranes by accident.

## 4.6 Water unit

The water unit comprises the following main components:



A	Tumbler filler
B	Flusher
C	Swiveling cuspidor bowl
D	Water alternative switch
E	Air switch
F	Filter
G	Purified water bottle
H	Assistant Element
I	Music Panel
J	Foot pedal

---

**Tumbler Filling**



**4.6.1 Tumbler filler**

Tumbler filling can be achieved via the key (*Tumbler Filling*) on the dentist element or on the assistant element.

See “4.4.3.2 Water unit area / Tumbler filler”.

**Flushing**



**4.6.2 Flushing the swiveling cuspidor bowl**

Flushing cuspidor can be achieved via the key (*Flushing*) on the dentist element or on the assistant element.

See “4.4.3.2 Water unit area / Flushing the cuspidor bowl”.

**4.6.3 Swiveling cuspidor bowl**

---

The cuspidor on the water unit can be swiveled approx. 90° to the both sides.

#### 4.6.4 Air switch



- The air switch is pulled to the *ON* position. Air is filled in the pure water bottle to supply the preset pressure for the pure water flowing to the dentist element.
- The air switch is pulled to the *OFF* position. Air pressure in the pure water bottle is taken off.

#### 4.6.5 Water alternative switch



- The alternative switch is pulled to the *OFF* position. The water unit supplies filtered water for the instruments of the dentist element.
- The alternative switch is pulled to the *ON* position. The water unit supplies pure water from the pure water bottle for the instruments of the dentist element.

#### 4.6.6 Pure water bottle

Pure water in the bottle is supplied for the instruments of the dentist element only when the air switch is pulled to the *NO* position and the alternative switch is pulled to the *Bottle water* position.

The bottle can be removed to pour pure water into it after the air switch much be pulled to the *OFF* position.



#### 4.7 Operating light

The operating light is attached to a height-adjustable support arm. It can be easily adjusted with the lamp handle to illuminate the treatment area.

### ▲ IMPORTANT

Also observe the operating instructions of the operating light.

## 5 Cleaning and maintenance by the practice team

To maintain the value and safe functioning of your dental unit, it is necessary to have it cared for, cleaned and disinfected by the practice team regularly. This will minimize the risk of contamination for patients and users and ensure proper functioning.

Remove any dirt and disinfectant residues using a mild commercial cleaning agent.

The time intervals, operational approach and cleaning agent refer to the following table.

---

## IMPORTANT

### **Care and cleaning intervals**

The time intervals specified for disinfection, care and cleaning are reference values.

Please adapt the time intervals to suit your personal method of working and your national requirements.

## IMPORTANT

### **Medicaments chemically react with the surface of the unit.**

Due to their high concentrations and the substances they contain, many medicaments can dissolve, etch, bleach or discolor surfaces.

- Clean any medicament residues off of the unit immediately with a moist cloth!

## NOTICE

### **Liquids can enter the unit during cleaning or disinfection**

Electrical components of the dental unit can be destroyed by liquids.

- Do not spray any liquids into the unit.
- To clean near openings, first spray the liquid onto a cleaning cloth. Then wipe over the unit with the cleaning cloth.

## NOTICE

### **Disinfectants can dissolve dyes in cleaning clothes.**

The outer surface of the unit may then be discolored by the dye.

- Do not clean or disinfect the unit with colored cleaning clothes.

Intervals	Cleaning And Maintenance Items	Operational Approach	Care and Clean Agents
After each patient	Disinfect the upholstery	Wipe over surface with disinfectant.	65% alcohol solution
	Disinfect the control panels	Wipe over surface with disinfectant.	65% alcohol solution
	Disinfect all handles	Wipe over surface with disinfectant.	75% alcohol solution
	Clean and disinfect the cuspidor bowl	Wipe over the surface of the tumbler filler with disinfectant.	75% alcohol solution
		Activate the cuspidor flushing of the cuspidor bowl for least 30 second.	Cleaning water
	Disinfect and sterilize the treatment instruments	Wipe over the surface of the 3-way syringe with disinfectant.	75% alcohol solution
		Sterilize the handpieces and the 3-way syringe tips.	Pressuresteam sterilization
	Disinfect the suction handpieces	Wipe over the surface of the suction handpieces with disinfectant and use new disposable cannulas.	75% alcohol solution
Daily	Cleaning the suction hoses	Pumping 200mL cleaning water to flushing the suction hoses.	Cleaning water
	Purge water lines of the instruments	1. Removed the instruments from their holders and held over the cuspidor bowl.	Cleaning water
		2. Step on the water pedal of the foot control for purging. Press the water key of the 3-way syringe for purging. The purging time is for least 30 second.	
	Rinsing water lines	Activate the cuspidor flushing of the cuspidor bowl for least one minute	Cleaning water
Disinfect the tray	Wipe over surface with disinfectant.	75% alcohol solution	

Intervals	Cleaning And Maintenance Items	Operational Approach	Care and Clean Agents
Daily	Disinfect the suction hoses	Pumping 500 ml disinfectant to flushing the suction hoses.	1000mg/L available chlorine
Weekly	disinfect the water line of the	Wipe over surface with disinfectant.	75% alcohol solution
	disinfect the water line of the cuspidor bowl	Pour 1 liter of the disinfectant into the cuspidor for flushing the water line.	1000mg/L available chlorine
	Clean the foot control	Wipe over surface with a moist cloth (water).	Cleaning water
	Clean the filter of the suction device	Open the filter flask and clean the filter with disinfectant.	1000mg/L available chlorine
Monthly	Change the cotton wool in the return-air bottle	Unscrew the return-air bottle and remove the cotton wool roll. Insert new cotton wool roll and screw up the bottle.	
	Clean the water and air filters	Open the water/air filter. Remove the filter element and clean it with cleaning water.	Cleaning water
Monthly	Disinfect water lines of the instruments	<ol style="list-style-type: none"> <li>1. Remove the pure water bottle and fill disinfectant. Screw up the bottle again. Pull the air switch to the <i>NO</i> position and pull the water alternative switch to the <i>Bottle Water</i> position.</li> <li>2. Removed the instruments from their holders and held over the cuspidor bowl; step on the water pedal of the foot control for purging. Press the water key of the 3-way syringe for purging. The purging time is for least 30 minute.</li> <li>3. Purge the water lines again with the pure water.</li> </ol>	50% hydrogen peroxide

---

## 6 Maintenance by the service engineer

### 6.1 Inspection and maintenance

In order to ensure the operational safety and reliability of your dental unit and to avoid damage due to nature wear, annual inspection and maintenance must be performed on your dental unit. This is done by an authorized service engineer.

An overview of the inspection and maintenance work performed is additionally recorded by the service engineer in the “Warranty Passport”.

### 6.2 Safety checks

Medical equipment is designed in such a way that the first occurrence of a fault does not create a hazard to the safety of patients, users or other persons. It is therefore important to detect such faults before a second fault occurs, which might then lead to safety hazards.

For that reason it is essential to perform safety tests every 2 years which aim particularly at detecting electrical faults (e.g. isolation defects). This is done by an authorized service engineer.



#### WARNING

The dental unit must not be operated if it has failed to pass the safety tests!



## 7 Malfunctions

Some common fault is following table:

<b>Fault</b>	<b>Reason Analysis</b>	<b>action</b>
Dripping handpiece	The mebrane of the pile-up valve has been damaged	Change a new mebrane
	The water valve switching on by air has been damaged	Change a new water valve
Dripping 3-way syringe	The O-ring or the spring of the water button has been damaged	Change a new O-ring or a spring.
The tumbler filler can't be shut off.	Core of the solenoid valve has been jammed	Remove and clean the valve core.
The flusher can't be shut off.	Core of the solenoid valve has been jammed	Remove and clean the valve core.
The tumbler filler can't open.	The solenoid valve has been damaged	Change a new solenoid valve.
	The circuit board in the water unit has been damaged	Change a new circuit board
The flusher can't open.	The solenoid valve has been damaged	Change a new solenoid valve.
	The circuit board in the water unit has been damaged	Change a new circuit board
The heater can't work	The heater has been damaged	Change a new heater
	The circuit board in the water unit has been damaged	Change a new circuit board
The saliva ejector is not enough suction	Water pressure is not enough.	Please add supercharging equipment.
	The filter has been blocked by dirt	Open and clean the filter
The spray aspirator is not enough suction	Air pressure is not enough.	Increase air pressure by adjusting the reducing valve
	The filter has been blocked by dirt	Open and clean the filter
The patient chair is malfunction	The motor has been damaged	Change a new motor
	The circuit board controlling the chair motors has been damaged	Change a new circuit board
	Fuse on the circuit board has been damaged	Find out the cause and change a new fuse.
Operating light can't open	The circuit board in the operating light has been damaged	Change a new circuit board
	Fuse of the operating light has been damaged	Find out the cause and change a new fuse.

---

## 8 Disposal

The dental unit not only belongs to medical equipment, it also belongs to electronic equipment. The product must not be disposed of as domestic refuse!

Please observe the disposal regulations applicable in your country.



































### NOTICE

Prior to dismount / disposal of the product, it must be fully prepared (cleaned / disinfected / sterilized).

Please contact your local dental equipment specialist for country specific information on disposal.

## 9 Overview of graphic symbols used

symbols	Definition	symbols	Definition
	Chair Memory Position		Clockwise to increase
	Choose doctor		Clockwise to reduce
	Chair up		Caution electric shock
	Chair down		Protective grounding
	Backrest up		Caution, consult accompanying documents
	Backrest down		Type B applied parts
	Entry/exit position	<b>IP</b>	Drop protection
	Emergency position		Caution, hot surface
	Dentist element up		Manufacturer
	Dentist element down		Date of manufacture
	X-ray viewer		Fragile-protect against knocks
	Operating light		Keep dry
	Tumbler filling		Transport upright with the arrow pointing upwards
	Flushing (the cuspidor)		Attention
	Heating		CE mark. A product with this mark meets the requirements of the applicable EU directive.
	Setting		Notice Mark
	clean-up position		

# 10 Electrical schematic diagram

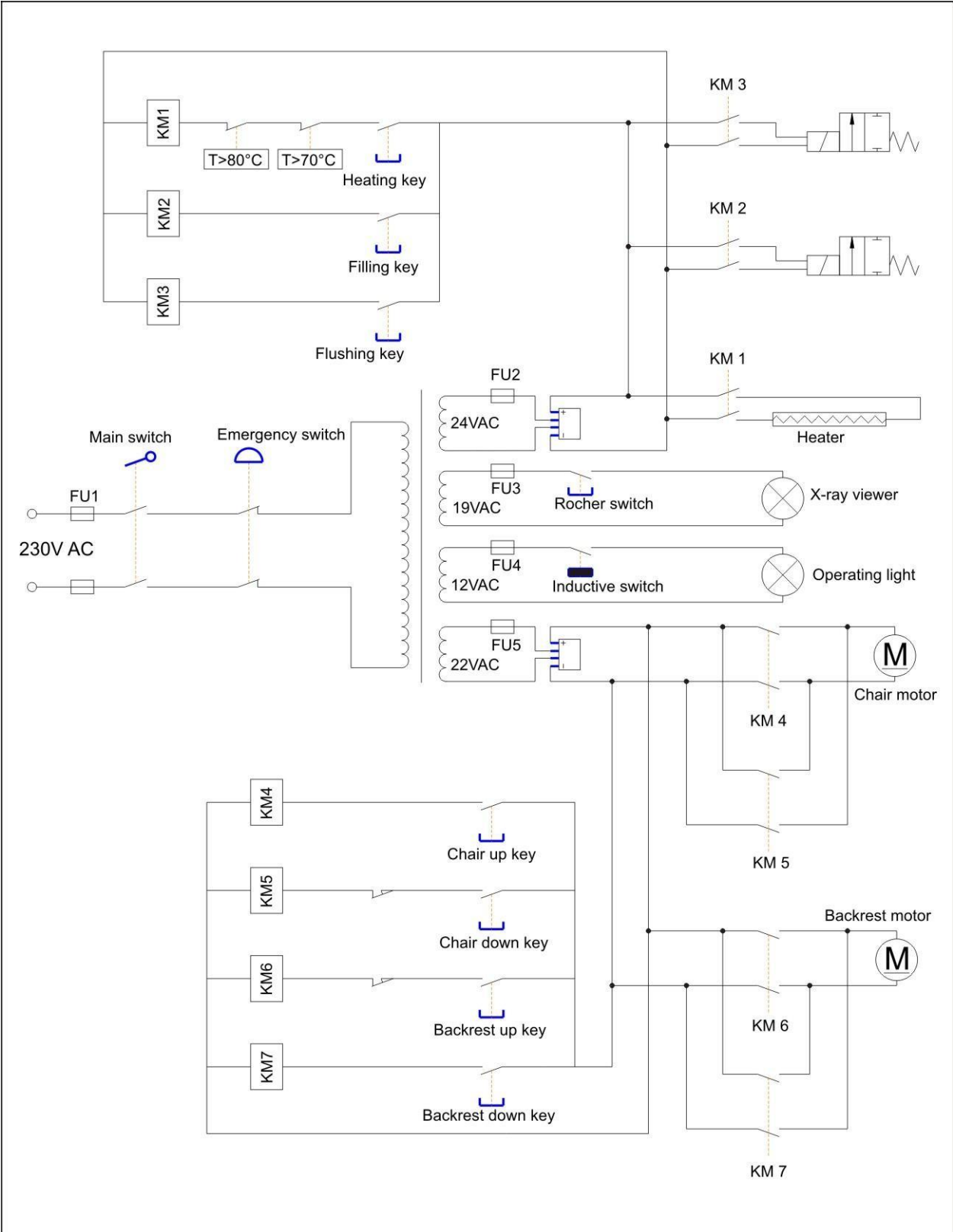

# 11 Water-air layout diagram

